

YJ Planar Fast Recovery Diode Die Specification

600V 5A, Fast recovery diode die based on silicon planar process
Part No.: FRD05A600AS-290A

Main Products Characteristics

- Average forward current: $I_{F(AV)} = 5A$
- Maximum operating junction temperature: $T_j = 150\text{ }^\circ\text{C}$
- Planar Construction
- Top metal: Al

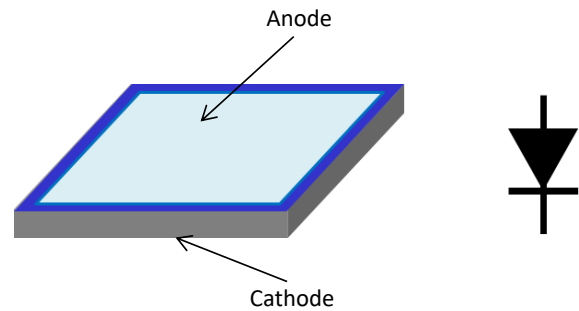

Maximum Ratings

Parameter	Symbol	Rating
Repetitive peak reverse voltage	V_{RRM}	600V
Average forward current	$I_{F(AV)}$	5A
Non-repetitive peak surge current ($t_p = 8.3\text{ ms}$, halfwave, 1 cycle)	I_{FSM}	50A
Storage temperature range	T_{stg}	-40 to +150 $^\circ\text{C}$
Maximum operating junction temperature	T_j	150 $^\circ\text{C}$

Static Electrical Characteristics ($T_a = 25^\circ\text{C}$)

Parameter	Symbol	Value	
		Spec	Typical
Reverse breakdown voltage $I_R = 50\mu\text{A}$	V_{BR}	630V	680V
Maximum forward voltage drop $I_F = 5A$, Pulse Test: $t_p = 380\text{ }\mu\text{s}$, $\delta \leq 2\%$	V_F	1.6V	1.45V
Reverse Recovery Time $I_F = 0.5A$, $I_R = 1A$, $I_{rr} = 0.25A$	T_{rr}	35ns	28ns
Maximum reverse current $V_R = V_{RRM}$ Pulse Test: $t_p = 10\text{ ms}$, $\delta \leq 2\%$	I_R	2 μA	0.02 μA

Device Schematics and Outline Drawing

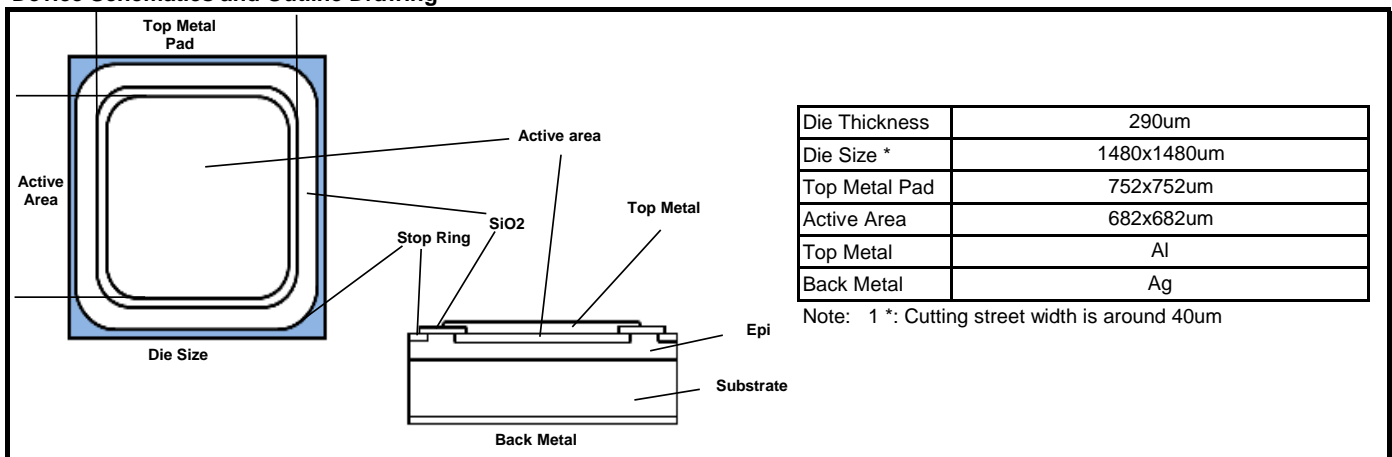

Important Notice

Specification apply to die only. Actual performance may degrade when assembled.

Yangjie Electronics does not guarantee device performance after assembly.
All operating parameters must be validated for each customer application by customer's technical experts.

Data sheet information is subjected to change without notice.

Recommended Storage Environment:

Store in original container, in dessicated nitrogen, with no contamination.

Shelf life for parts stored in above condition is 2 years.

If the storage is done in normal atmosphere shelf life is reduced to 6 months.