

Silicon Carbide Power MOSFET (N-Channel Enhancement)

V_{DS}	650V
I_D (25°C)	57A
$R_{DS(on)}$	50mΩ

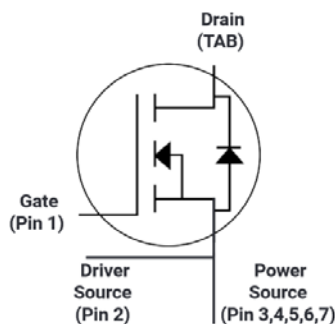

Features

- High speed switching
- Essentially no switching losses
- Reduction of heat sink requirements
- Maximum working temperature at 175 °C
- High blocking voltage
- Fast Intrinsic diode with low recovery current
- High-frequency operation
- Halogen free, RoHS compliant

Typical Applications

Typical applications are in power factor correction(PFC), solar inverter, uninterruptible power supply, motor drives, photovoltaic inverter, electric car and charger.

Mechanical Data

- **Package:** TO263-7L
- **Terminals:** Tin plated leads
- **Polarity:** As marked

■Maximum Ratings ($T_c=25^\circ\text{C}$ Unless otherwise specified)

PARAMETER	SYMBOL	UNIT	VALUE	TEST CONDITIONS	NOTE
Device marking code				D206550B7GH	
Drain source voltage @ $T_j=25^\circ\text{C}$	$V_{DS,max}$	V	650	$V_{GS}=0\text{ V}$, $I_D=100\mu\text{A}$	
Gate source voltage @ $T_j=25^\circ\text{C}$	$V_{GS,max}$	V	-10/+25	Absolute maximum values (AC f > 1Hz, duty cycle < 1%)	Note1
Gate source voltage @ $T_j=25^\circ\text{C}$	$V_{GS,op}$	V	-5/+20	Recommended operational values	
Continuous drain current @ $T_c=25^\circ\text{C}$	I_D	A	57	$V_{GS}=20\text{V}$, $T_c=25^\circ\text{C}$	Fig.14
Continuous drain current @ $T_c=110^\circ\text{C}$			38	$V_{GS}=20\text{V}$, $T_c=110^\circ\text{C}$	
Pulse Drain Current	$I_{D,pulse}$	A	127	Limited by t_{pw}	Fig.15
Avalanche energy, Single Pulse	E_{AS}	mJ	500	$V_{DD}=75\text{V}$, $L=30\text{mH}$	
Power Dissipation	P_{TOT}	W	234	$T_c=25^\circ\text{C}$, $T_j = 175^\circ\text{C}$	Fig.13
Operating junction and Storage temperature range	T_j, T_{stg}	$^\circ\text{C}$	-55 to +175		
Soldering temperature	T_L	$^\circ\text{C}$	260	1.6mm (0.063") from case for 10s	



■Static Electrical Characteristics (Tc=25°C unless otherwise specified)

PARAMETER	SYMBOL	UNIT	Min.	Typ.	Max.	Test Conditions	Note
Gate threshold voltage	$V_{GS(th)}$	V	1.5	2.6	4.0	$V_{DS}=V_{GS}$, $I_D=20mA$	Fig.4, 11
Drain source breakdown voltage	$V_{(BR)DSS}$	V	650			$V_{GS}=0$, $I_D=100\mu A$	
Zero gate voltage drain current	I_{DSS}	μA		<1	50	$V_{DS}=650V$, $V_{GS}=0V$	
				10	500	$V_{DS}=650V$, $V_{GS}=0V$, $T_j=175^\circ C$	
Gate source leakage current	I_{GSS}	nA			250	$V_{GS}=20V$, $V_{DS}=0V$	
Current drain source on-state resistance	$R_{DS(on)}$	m Ω		50	65	$V_{GS}=20V$, $I_D=20A$	Fig.3, 5, 6
				65		$V_{GS}=20V$, $I_D=20A$, $T_j=175^\circ C$	
Transconductance	g_f	S		10.5		$V_{DS}=20V$, $I_D=20A$	

■Dynamic Electrical Characteristics (Tc=25°C unless otherwise specified)

PARAMETER	SYMBOL	UNIT	Min.	Typ.	Max.	Test Conditions	Note
Input capacitance	C_{iss}	pF		1850		$V_{DS}=400V$, $V_{GS}=0V$, $T_j=25^\circ C$, $f=1MHz$, $V_{AC}=25mV$	Fig.10
Output capacitance	C_{oss}			208			
Reverse capacitance	C_{rss}			33			
Coss stored energy	E_{oss}	μJ		24			Fig.12
Gate source charge	Q_{gs}	nC		30		$V_{DS}=400V$, $V_{GS}=-5/20V$, $I_D=20A$	Fig.16
Gate drain charge	Q_{gd}			43			
Gate charge	Q_g			121			
Short-Circuit Withstand Time	t_{sc}	μs		6		$V_{GS}=-5/20V$, $V_{DS}=400V$, $I_{sc}=400A$ $R_G=30\Omega$	
Internal Gate Resistance	$R_{G(int)}$	Ω		2.0	5.0	$f=1MHz$, $V_{AC}=25mV$	

■Switching Characteristics (Tc=25°C unless otherwise specified)

PARAMETER	SYMBOL	UNIT	Min.	Typ.	Max.	Test Conditions	Note
Turn on delay time	$t_{d(on)}$	ns		6.5		$V_{DD}=400V$, $V_{GS}=-5/+20V$, $I_D=20A$, $L=100\mu H$, $R_{G(ext)}=2.7\Omega$	Fig.17, 18
Rise time	t_r			15.6			
Turn off delay time	$t_{d(off)}$			18.5			
Fall time	t_f			9			
Turn on switching energy	E_{on}	μJ		99			
Turn off switching energy	E_{off}			18			



■Body diode characteristics (Tc=25°C unless otherwise specified)

PARAMETER	SYMBOL	UNIT	Min.	Typ.	Max.	Test Conditions	Note
Diode forward voltage	V_{SD}	V		4.0		$V_{GS}=0V, I_{SD}=10A$	Fig.8
Continuous diode forward current	I_S	A		40.5		$V_{GS}=0V, T_c=25^\circ C$	
Reverse recovery time	t_{rr}	nS		58		$V_{DS}=400V, V_{GS}=0V, I_{SD}=10A, di/dt=300A/\mu S$	
Reverse recovery charge	Q_{rr}	nC		122			
Peak reverse recovery current	I_{rrm}	A		3.75			

Note 1: When using SiC Body Diode the maximum recommended $V_{GS} = -5V$

■Thermal Characteristics (Ta=25°C Unless otherwise specified)

PARAMETER	SYMBOL	UNIT	Value
Thermal resistance	$R_{\theta J-C}$	$^\circ C/W$	0.64

■Typical Characteristics

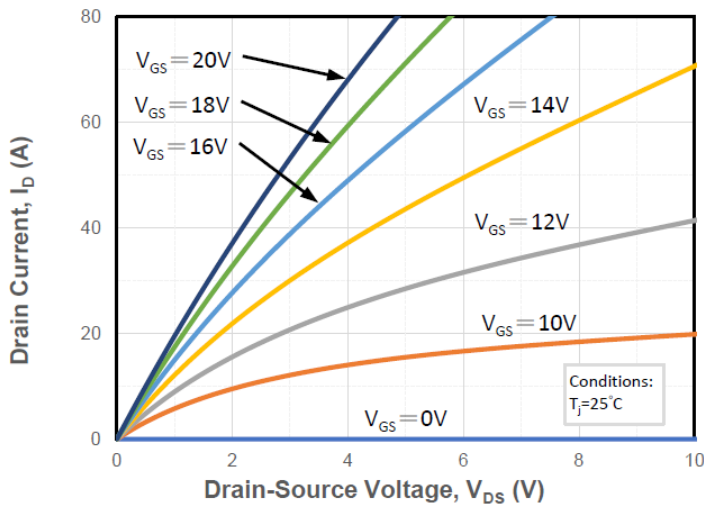

Figure 1. Output Characteristics Tj = 25°C

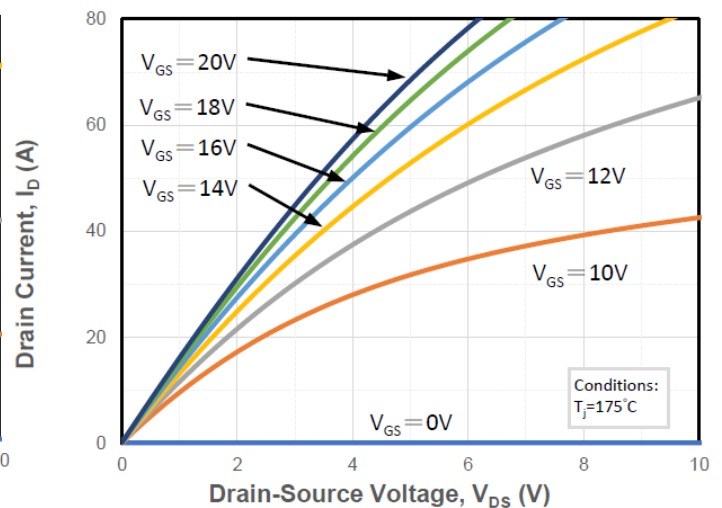

Figure 2. Output Characteristics Tj = 175°C

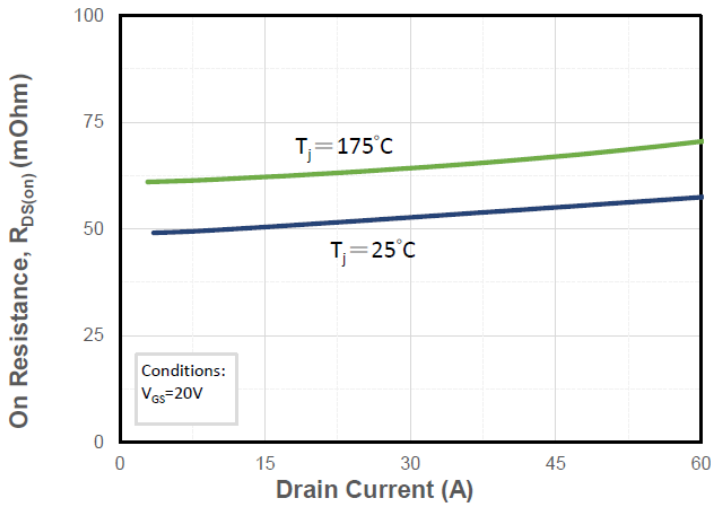

Figure 3. On-resistance vs. drain current

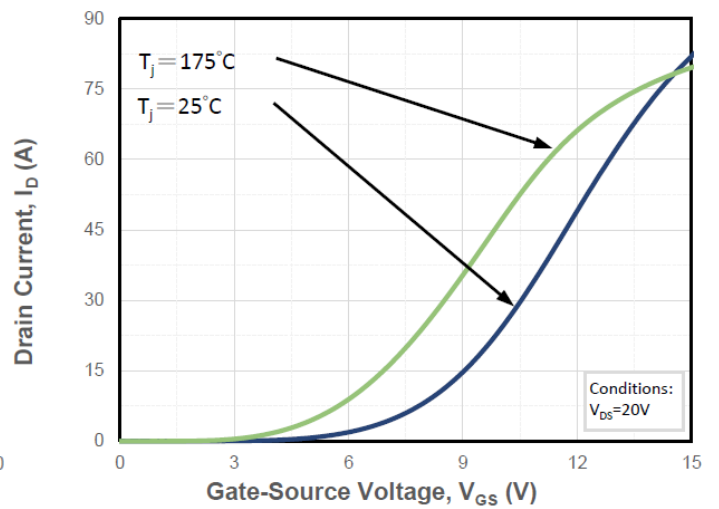

Figure 4. Transfer Characteristics for various Tj

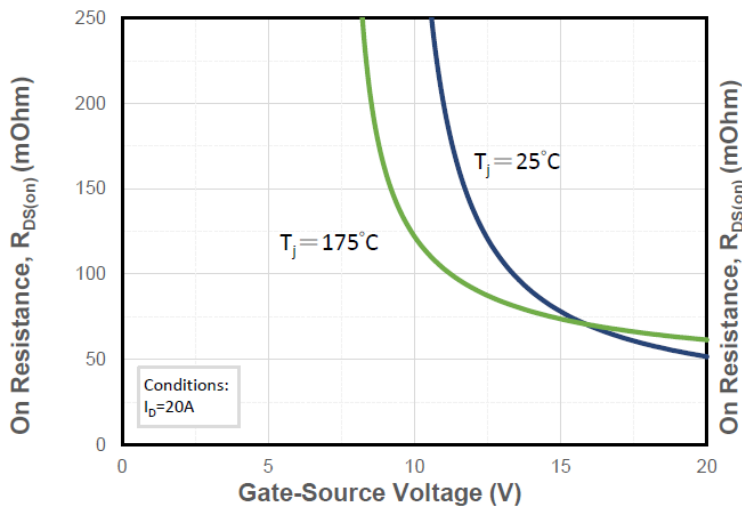

Figure 5. On-resistance vs. gate voltage for various Tj

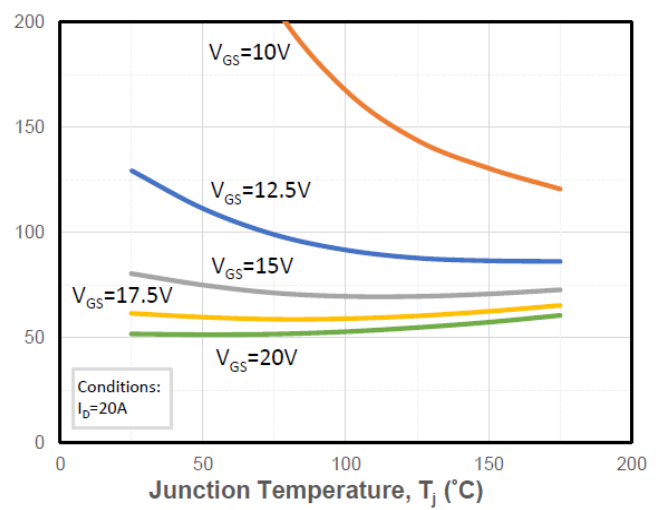

Figure 6. On-resistance vs. Temperature for various Gate voltage

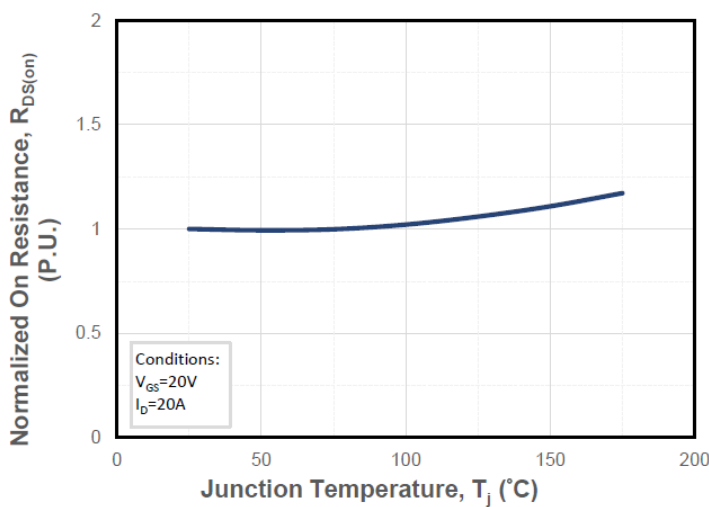

Figure 7. Normalized On-Resistance vs. Temperature

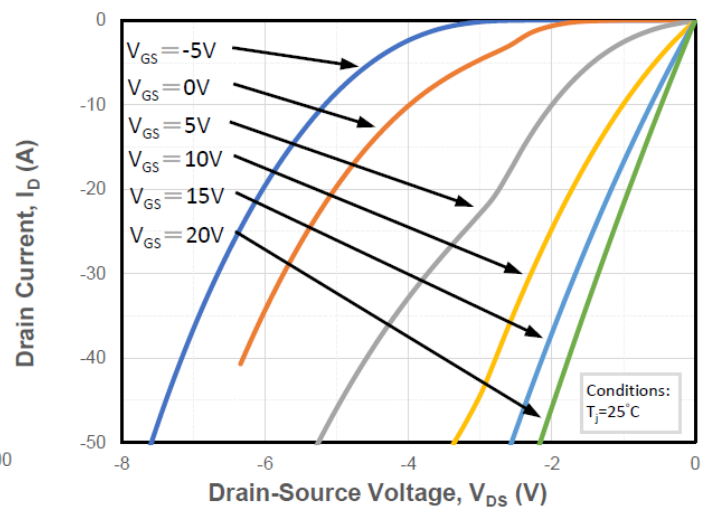

Figure 8. Reverse Output Characteristics at Tj = 25°C

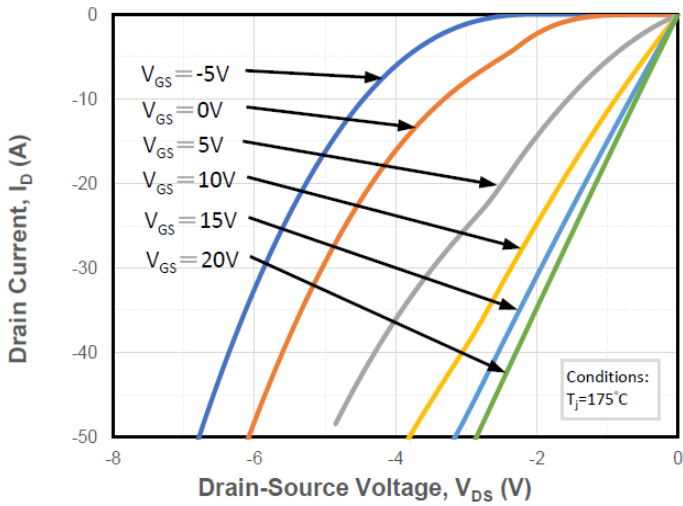

Figure 9. Reverse Output Characteristics at Tj = 175°C

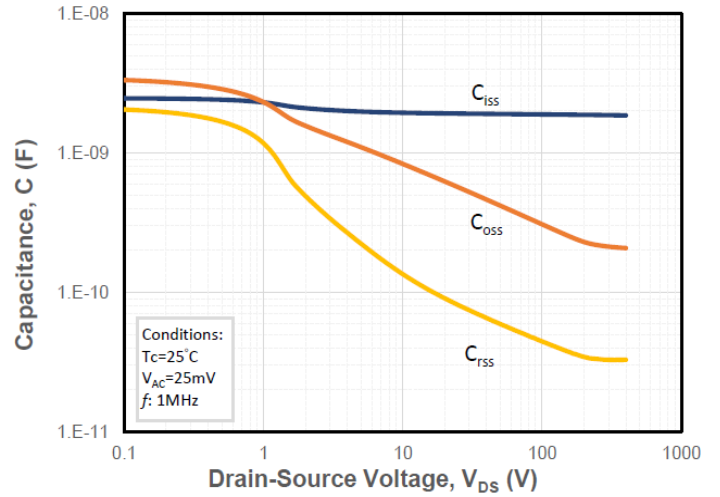

Figure 10. Capacitances vs. Drain to Source Voltage

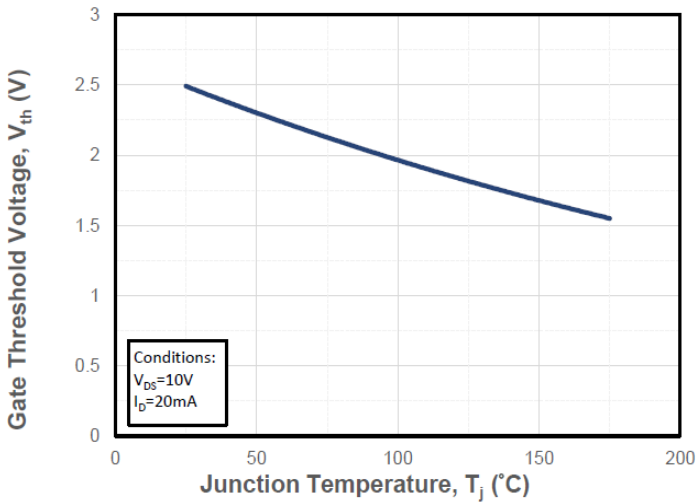

Figure 11. Threshold voltage vs. temperature

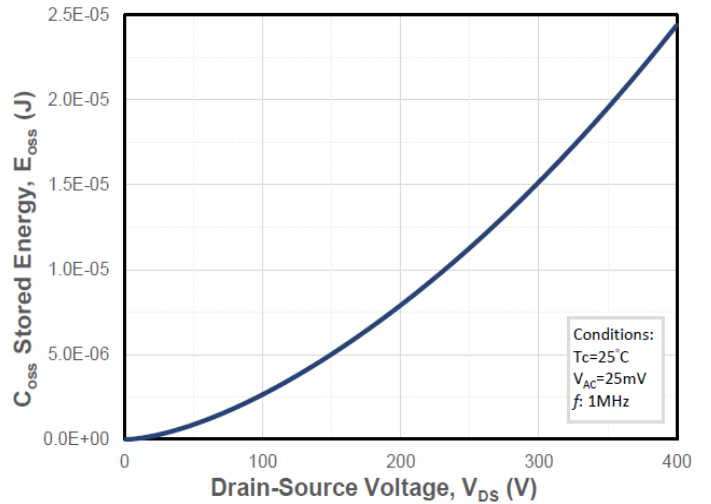

Figure 12. Output Capacitor Stored Energy

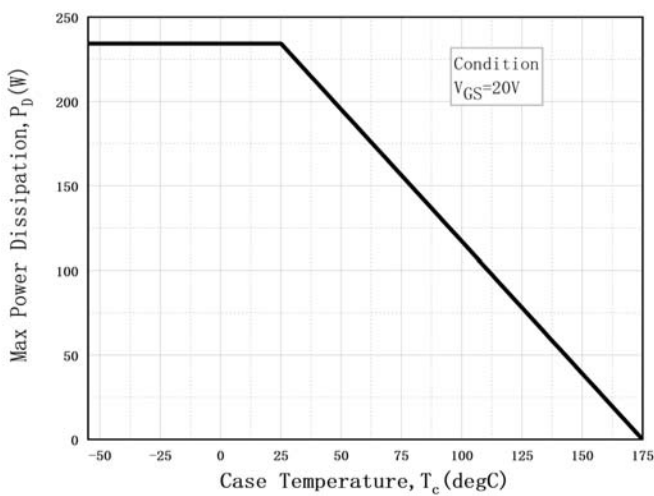

Figure 13. Maximum Power Dissipation Derating vs. Case Temperature

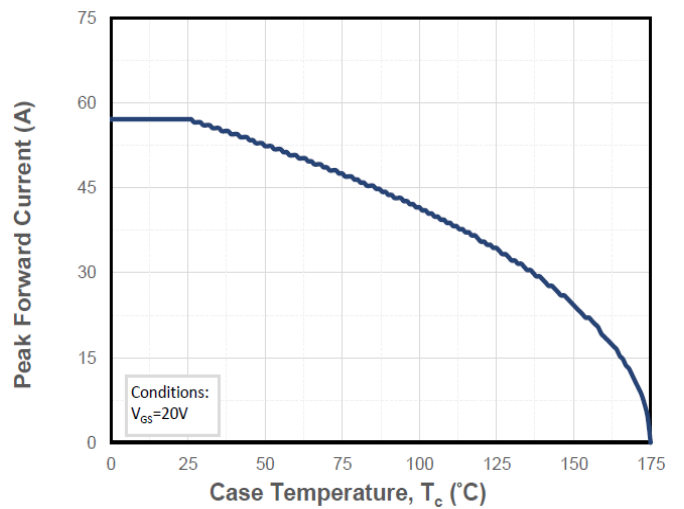

Figure 14. Drain Current Derating vs. Case Temperature

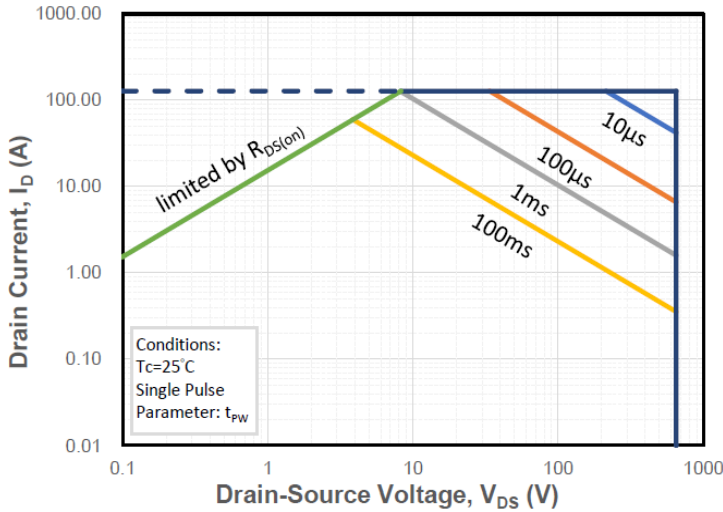

Figure 15. Safe Operating Area

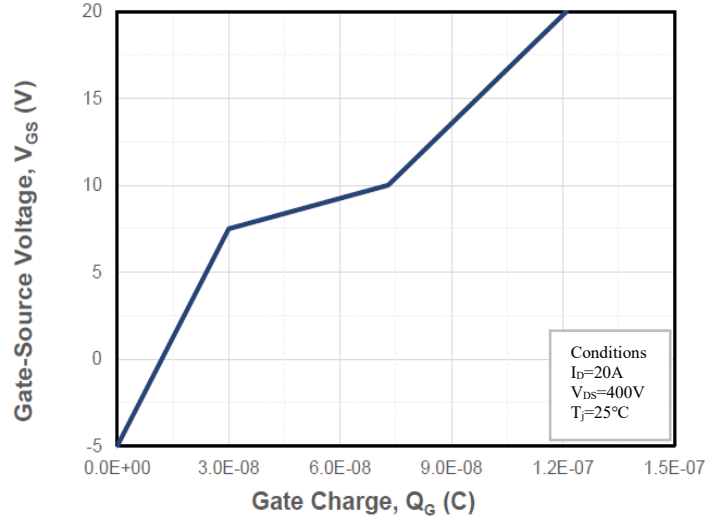

Figure 16. Gate Charge Characteristics

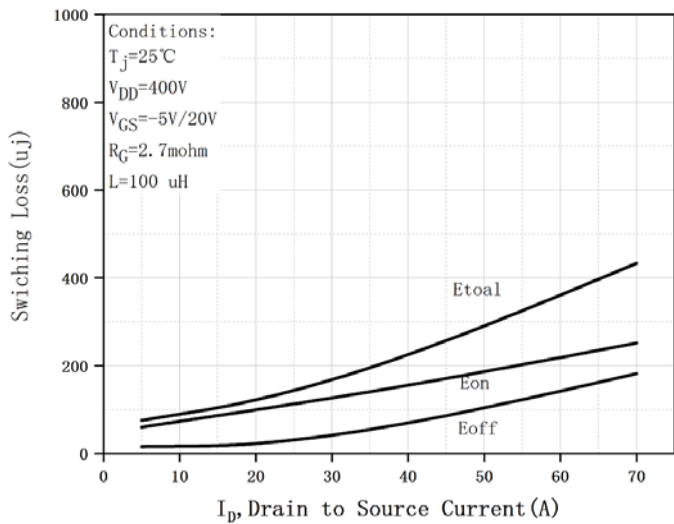

Figure 17. Clamped Inductive Switching Energy vs. Drain Current

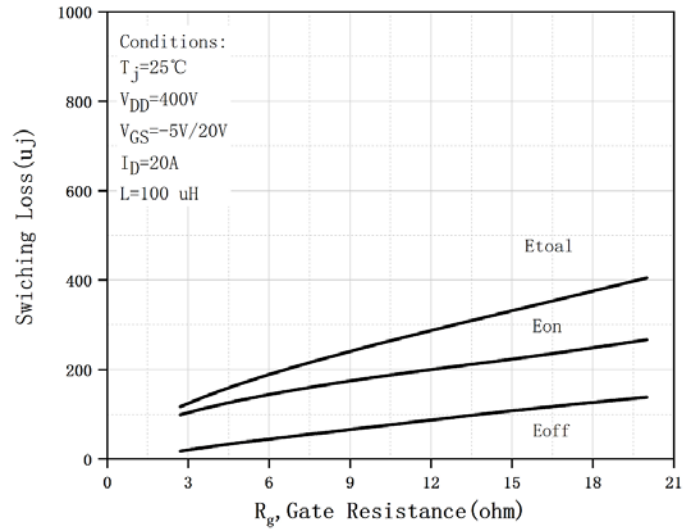

Figure 18. Clamped Inductive Switching Energy vs. External Gate Resistor ($R_{G(ext.)}$)

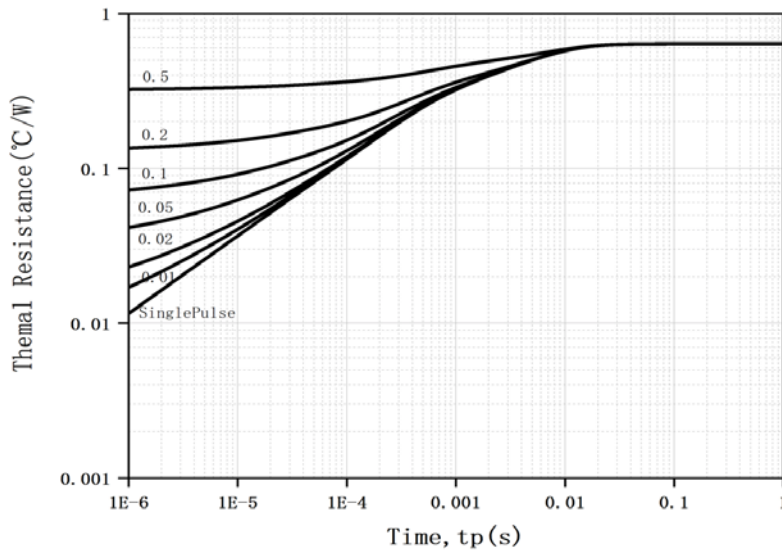

Figure 19. Transient Junction to Case Thermal Impedance

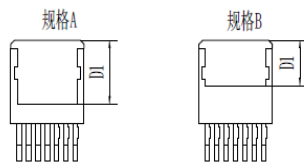
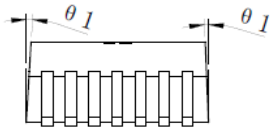
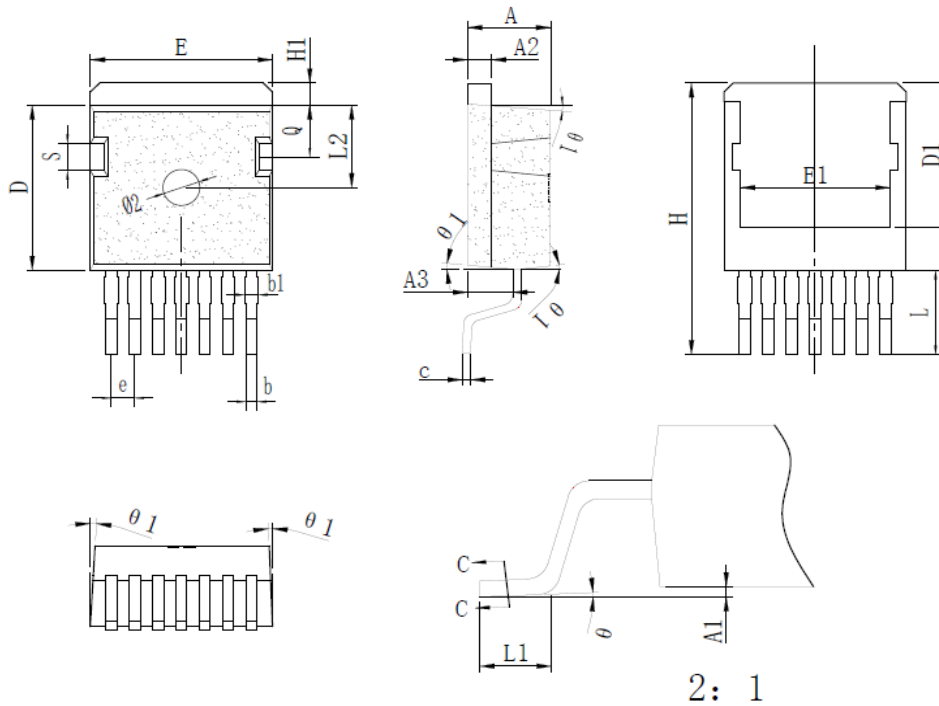

Figure 20. Schematic of Resistive Switching



Figure 21. Switching Times Definition

■Outline Dimensions



* 为关键管控尺寸

SYMBOL	mm		
	MIN	NOM	MAX
*A	4.30	4.40	4.50
*A1	0.00	0.10	0.20
*A2	1.22	1.27	1.32
*A3	2.30	2.40	2.50
*b	0.50	0.60	0.70
*b1	-	-	0.63
*c	0.45	0.50	0.55
*D	9.15	9.30	9.45
D1	规格A: 8.00REF		
	规格B: 5.70REF		
*E	10.12	10.16	10.20
E1	8.20	8.40	8.60
*e	1.25	1.27	1.29
*H	14.85	15.00	15.15
H1	1.10	1.20	1.30
*L	4.50	4.70	4.90
L1	1.70	2.00	2.30
L2	4.55	4.65	4.75
S	1.40	1.50	1.60
Q	2.80	2.90	3.00
*theta	0°	2.5°	8°
theta1	5°	7°	9°



Disclaimer

The information presented in this document is for reference only. Yangzhou Yangjie Electronic Technology Co., Ltd. reserves the right to make changes without notice for the specification of the products displayed herein to improve reliability, function or design or otherwise.

The product listed herein is designed to be used with ordinary electronic equipment or devices, and not designed to be used with equipment or devices which require high level of reliability and the malfunction of which would directly endanger human life (such as medical instruments, transportation equipment, aerospace machinery, nuclear-reactor controllers, fuel controllers and other safety devices), Yangjie or anyone on its behalf, assumes no responsibility or liability for any damages resulting from such improper use of sale.

This publication supersedes & replaces all information previously supplied. For additional information, please visit our website [http:// www.21yangjie.com](http://www.21yangjie.com) , or consult your nearest Yangjie's sales office for further assistance.